



**2025**



**KABLO TAŞIMA SİSTEMLERİ**  
**CABLE TRANSPORT SYSTEMS**

## HAKKIMIZDA

1985 yılından bu yana edindiğimiz saç kablo taşıyıcıları ve aksesuarları alanındaki bilgi birikimiyle, 1993 yılında SİES ELEKTRİK olarak sektöre adım attık. Geçmişten aldığımız güç ve güvenle, sektörde yeni bir dinamizm yaratarak kısa sürede saygın bir konuma ulaştık.

Piyasanın değişen koşullarına uyum sağlayarak sürekli kendimizi yenileyen firmamız, kaliteden ve müşteri memnuniyetinden asla ödün vermeden büyümeye devam etti. Bugün, yurt içi ve yurt dışında birçok büyük ve başarılı projede imzamız bulunmaktadır.

Müşterilerimizin ihtiyaçlarını anlamak, onların öneri ve isteklerini karşılıklı memnuniyet çerçevesinde çözmek, bizim temel ilkelerimizden biridir. SİES ELEKTRİK olarak, her zaman kaliteli hizmet ve güvenilir çözümler sunmayı taahhüt ediyoruz.

Saygılarımızla,

## ABOUT US

Since 1985, with the knowledge we have gained in the field of sheet metal cable carriers and accessories, we stepped into the sector as SİES ELEKTRİK in 1993. With the strength and confidence we have gained from the past, we have reached a respected position in a short time by creating a new dynamism in the sector.

Our company, which constantly renews itself by adapting to the changing conditions of the market, has continued to grow without sacrificing quality and customer satisfaction. Today, we have our signature on many large and successful projects in Turkey and abroad.

Understanding the needs of our customers and solving their suggestions and requests within the framework of mutual satisfaction is one of our basic principles. As SİES ELECTRIC, we are always committed to providing quality service and reliable solutions.

Sincerely,



BORU SİSTEMİ

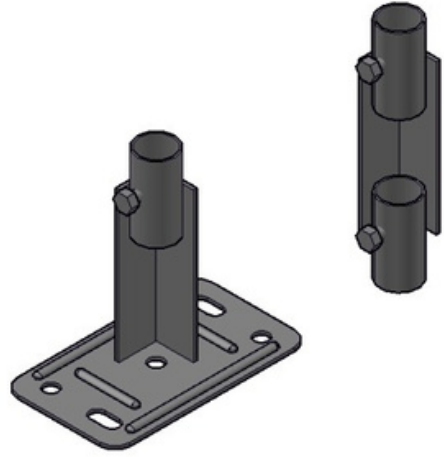

PIPE SYSTEM

### BORU ELEMANI PIPE MATERIAL

SİPARİŞ NO ORDER CODE	R (mm)	KALINLIK THICKNESS (mm)	AĞIRLIK WEIGHT (Kg/M)
SB-1	25	1,00	0,60
SB-2	42	1,50	1,60

### 90° DÖNÜŞLER - KANAL ÇIKIŞ ELEMANI 90° BENDS - TRAY OUT UNIT

SİPARİŞ NO ORDER CODE	R (mm)	KALINLIK THICKNESS (mm)	AĞIRLIK WEIGHT (Kg/Ad)
SLB-1E	25	1,50	0,15
SLB-2E	42	2,00	1,60
SBK-Ç	-	1,50	0,08

### BORU EK ELEMANI - BORU KELEPÇESİ STRAIGHT CONNECTOR - PIPE CLAMP

SİPARİŞ NO ORDER CODE	R (mm)	KALINLIK THICKNESS (mm)	AĞIRLIK WEIGHT (Kg/Ad)
SB-1E	32	2,00	0,12
SB-2E	48	2,00	0,35
SBK-1	25	1,50	0,03
SBK-2	48	1,50	0,05

### YERE TESPİT VE BORU ÇIKIŞ ELEMANI DETECTION AND PIPE ELEMENT OUTPUT TO GROUND

SİPARİŞ NO ORDER CODE	R (mm)	KALINLIK THICKNESS (mm)	AĞIRLIK WEIGHT (Kg/Ad)
SB-1Y	32	2,00	0,35
SB-2Y	48	2,00	0,62
SB-1Ç	32	2,00	0,30
SB-2Ç	48	2,00	0,85

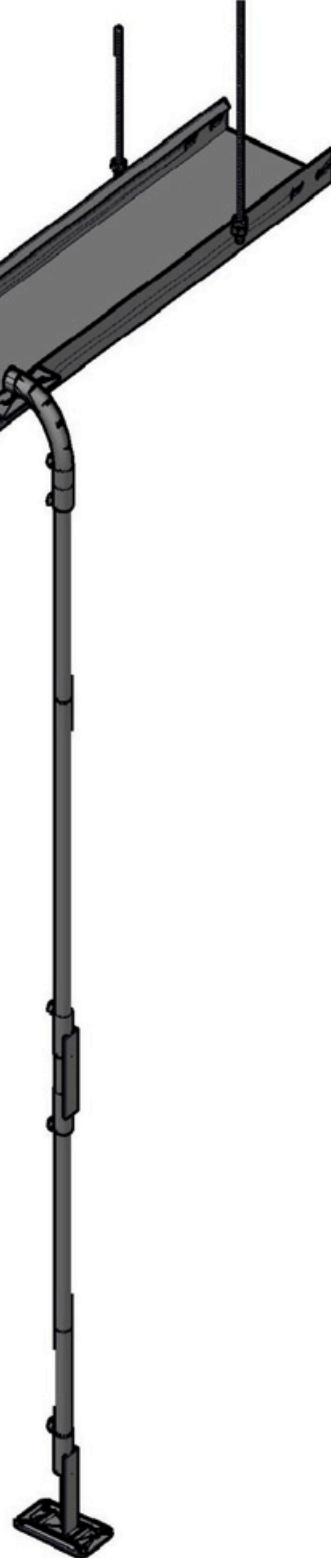
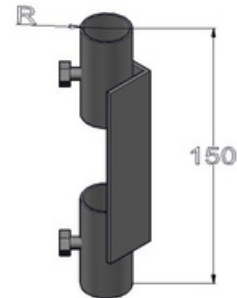
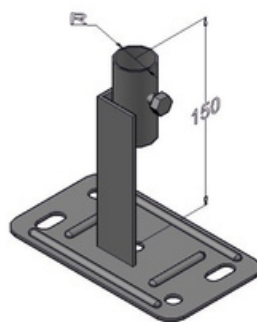
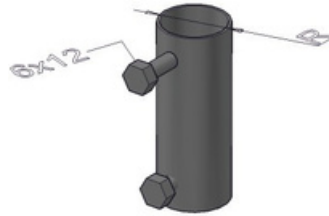
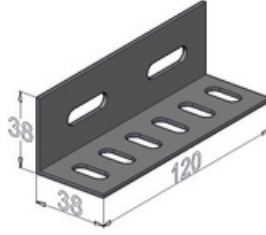

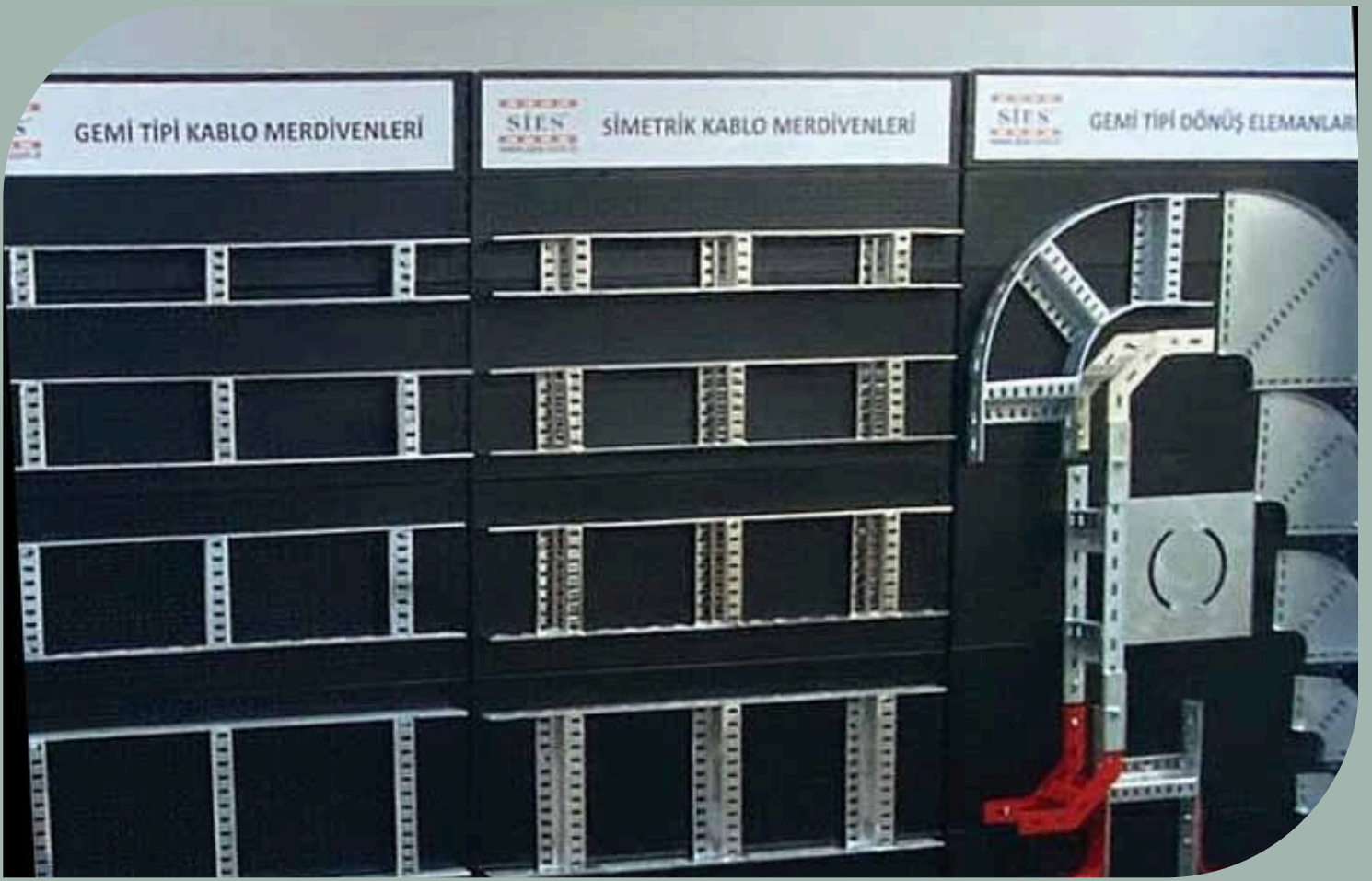

**SIES®**

**GEMİ TİPİ KABLO TAŞIYICILARI  
MARINE TYPE CABLE CARRIERS**



**FABRİKA - FACTORY**

Yeşilce Mah. Daim Sokak No:6/A Kağıthane/ İstanbul  
(0212) 324 00 78 - 324 00 98 - 324 00 99  
(0507) 299 32 63  
[www.sies.com.tr](http://www.sies.com.tr)  
[sies@sies.com.tr](mailto:sies@sies.com.tr)

**PERPA SATIŞ OFİSİ-PERPA SALES OFFICE**

Perpa Ticaret Merkezi A Blok Kat : 5 No: 104  
Okmeydanı - İstanbul  
(0541) 240 80 75